

Keysight Technologies

USB 2.0 Compliance Testing with Infiniium Oscilloscopes

Application Note

Introduction

Universal Serial Bus (USB) burst on the scene in 1995 delivering a revolutionary way to connect personal computers and devices. Allowing hot-plug capability, USB has introduced ease-of-use to the PC device market by providing a simple connection scheme and protocol for a wide variety of computer devices, ranging from keyboards and mice to high-bandwidth devices such as printers, scanners, and cameras.

USB has now successfully replaced aging serial and parallel ports as the connection of choice for both device manufacturers and end users. Whereas cable length and device expansion were limitations with older serial and parallel connections, they are no issue for USB. Amazingly, it allows devices to exist up to 30-meters away from the host, and allows up to 127 devices to be connected to a single host and port at once through a series of USB hubs. The ability to talk directly to devices or to devices through hubs allows for this incredible expansion capability.

USB 1.1 worked best for slower human-interface devices such as mice and keyboards, with low-speed operating at 1.5-Mb/s and full-speed operating at 12-Mb/s. Higher-bandwidth devices were severely limited by these relatively slow data transfer rates. As a result, the USB-Implementers Forum (USB-IF) introduced the fully backward compatible USB 2.0 in May 2000, which resulted in a 40-fold increase in data throughput for hi-speed over full-speed. USB 2.0 operates at 480-Mb/s—ideal for devices such as video-conferencing cameras and high-resolution printers. For more information, see the official USB-IF (USB Interoperability Forum) website at www.usb.org.

Who Should Read This Application Note?

Digital designers and developers working towards USB 2.0 compliance.

Table of Contents

Introduction	2
Basic Specifications	3
Full/Low-Speed Test Suite	4
Full/Low-Speed Test Fixture	4
Signal Quality Test	5
In-Rush Current Check	7
Droop and Drop Testing	8
Back-Drive Voltage Test	9
Hi-Speed Electrical Test Suite	9
Hi-Speed Electrical Test Tool	9
Hi-Speed Test Fixture	10
Hi-Speed Signal Quality Test	11
Monotonicity	11
Packet Parameters Test	12
Receiver Sensitivity	12
CHIRP Timing Test	13
Impedance Measurements	14

Basic Specifications

As listed previously, USB 2.0 comprises three different data transfer rates—low-speed, full-speed, and hi-speed.

Four wires compose the cable system— V_{BUS} , D+, D-, and ground. Devices may be either bus-powered, with 500-mA maximum bus current withdraw, or self-powered, meaning they have their own power supply. D- and D+ is a differential signal pair that serves as the primary information carrier between the host, hubs, and devices. USB 2.0 supports three different types of data transfer: interrupt, bulk, or isochronous. Control packets containing commands or query parameters may also be sent by the host.

The flexibility inherent in USB is a direct result of the specifications above and the stringent regulations and compliance testing mandated by the USB-IF. There are three kinds of compliance tests: framework test, interoperability test, and electrical test. This document only discusses Infiniium’s electrical test solution.

Low, full, and hi-speed USB require compliance with the signal quality, in-rush current check, droop/drop and back drive voltage electrical tests. Hi-speed requires compliance with an additional suite of electrical tests—hi-speed signal quality, receiver sensitivity, CHIRP timing, and packet parameters. Older methods of compliance testing included first capturing the signals on a scope, then moving the data to a PC so it could be cropped, stored in a .tsv format, and finally analyzed in MATLAB. The Keysight Technologies, Inc. Infiniium USB Test Option is the first scope solution in the industry that utilizes the official USB-IF MATLAB script. As the result, it provides an affordable, trustworthy, single-box, compliance solution—allowing you to say, as did one of our customers, “I know I’m going to pass!”

	Data Rates	Rise Times
Low-speed (LS)	1.5 Mb/s	75 ns – 300 ns
Full-speed (FS)	12 Mb/s	4 ns – 20 ns
Hi-speed (HS)	480 Mb/s	500 ps

Table 1. USB 2.0 speed specifications.

USB Test	Test Type	Report Output
Signal integrity	FSFE, LSFE, LSNE, HSFE, HSNE	Overall result, Signal eye, EOP width measurement, Signaling rate measurement Crossover voltage measurement, Jitter measurement, Signal data diagram, Eye diagram, Rise and fall time, Non-monotonic test
Inrush Current	Hot Plug, Keysight Config, Keysight Resume, LP Config, LP Resume	Overall result, Inrush current measurement, Inrush current graph
Drop/Droop	System, Self Powered Hub, Bus Powered Hub	Overall Result, Voltage no load measurement, Voltage loaded measurement Drop measurement, Droop measurement

Table 2. Tests included with Keysight USB test option N5416A. (USB test options E2645A, N2854A, N2855A, and E2683A have been discontinued)

Full/Low-Speed Test Suite

Keysight test equipment has been approved by the USB-IF.



Figure 1. Keysight Infiniium at official USB-IF Plugfest.

Full/Low-Speed Test Fixture

The basic USB 2.0 electrical test suite includes signal quality, in-rush current check, and droop/drop tests. A SQuIDD (Signal Quality inrush Droop Drop) fixture must be used for these tests. Keysight provides a SQuIDD board that is ordered separately as part number E2646B. The USB-IF exclusively uses the Keysight SQuIDD board for official compliance testing.

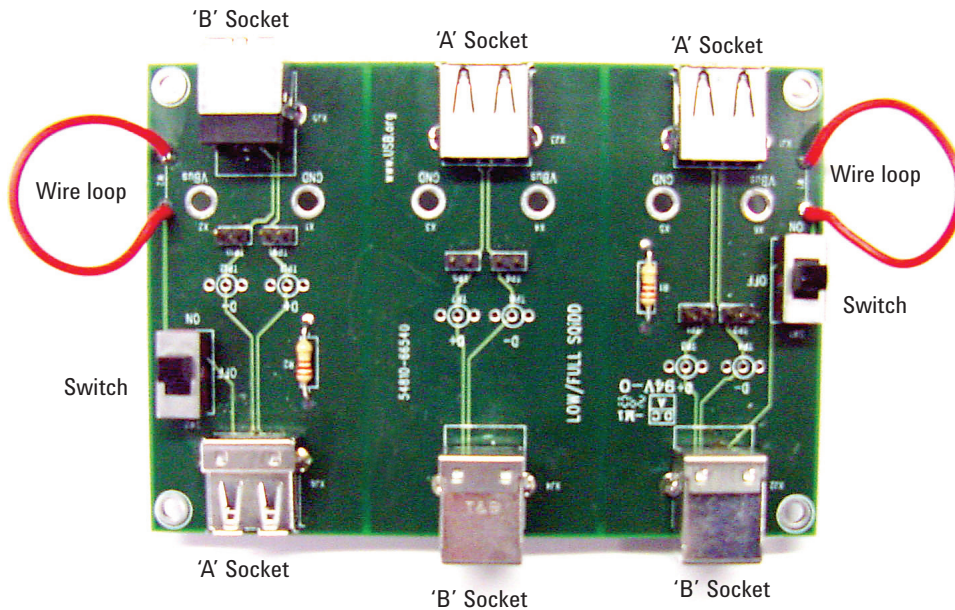

Figure 2. Keysight SQuIDD board.

Signal Quality Test

Using an oscilloscope to measure transceiver characteristics, the signal quality test looks at:

- Signal eye
- End of Packet (EOP) width
- Signaling Rate
- Rise/Fall Times
- Cross-over Voltage Range
- Consecutive Jitter
- Paired JK Jitter
- Paired KJ Jitter

Signal quality testing can be performed for either upstream data or downstream data. In the case of upstream testing, signals travelling from the device to the host are captured and analyzed. Downstream testing performs just the opposite, capturing signals travelling from the host towards the device or terminating hub. Figure 3 shows a captured downstream packet on the Infiniium scope with the USB Test Option.

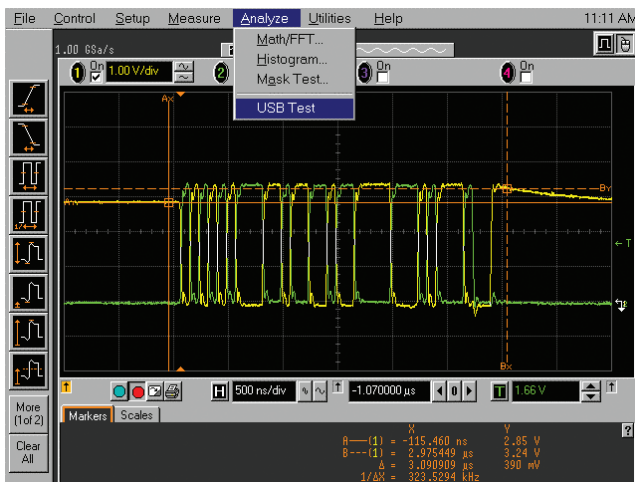

Figure 3. Captured downstream packet.

Signal Quality Test (continued)

Once the USB full speed test is launched, other conditions must also be set in the software. For signal quality tests, these additional conditions include tier and near end/far end. The tier refers to the distance between the device and the host computer. If the device is connected directly to the host computer, the tier equals 1. If the device is separated from the host computer by 3 hubs, the tier equals 4. Compliance testing mandates that testing occur at a minimum tier of 6; therefore, Keysight recommends that tests always be performed with a tier of 6. Test results may be stored in a data file on the Infiniium's C: drive, or may also be stored to a USB flash drive.

Infiniium displays all test results in an html format, including the eye diagram.

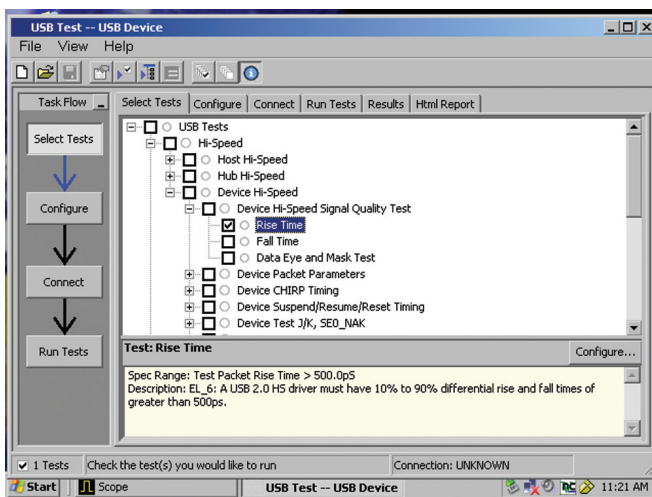

Figure 4. Infiniium USB test menu.

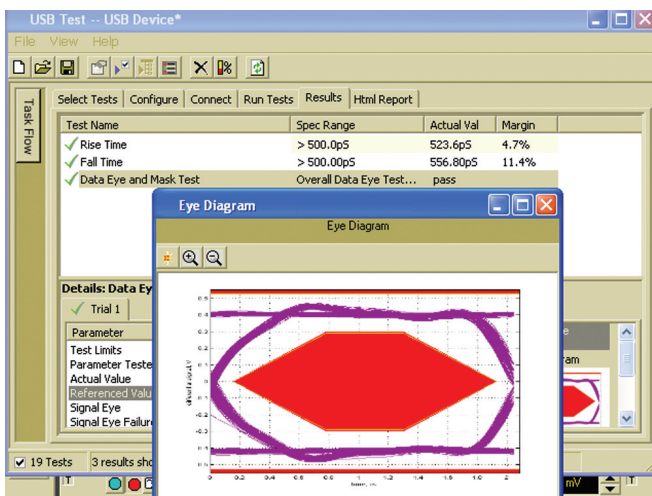

Figure 5. Infiniium signal quality test results.

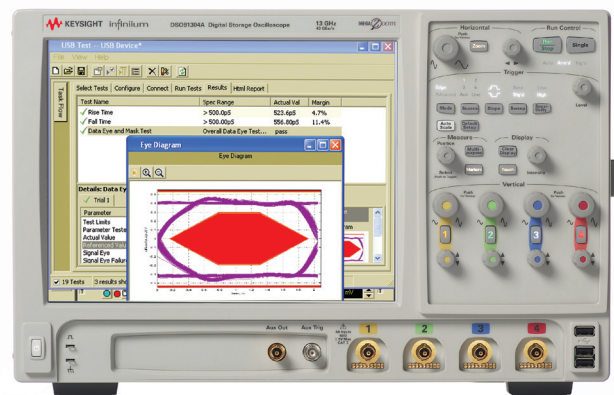

Figure 6. Infiniium-generated eye diagram for USB test.

In-Rush Current Check

The nature of electronic devices dictates that a surge of current will occur, followed by a lesser steady-state current level, when power is applied to a device. The hot-pluggable nature of USB requires that the total inrush surge current be tested to ensure that it remains within the limits for the device. If the inrush current does not remain within its limits (100 mA), not only can it cause damage to the device, but it can also take power from other devices connected to the same port.

The USB 2.0 specification outlines a total inrush surge current limit of 50- μ C. A waiver is granted at 150 μ C.

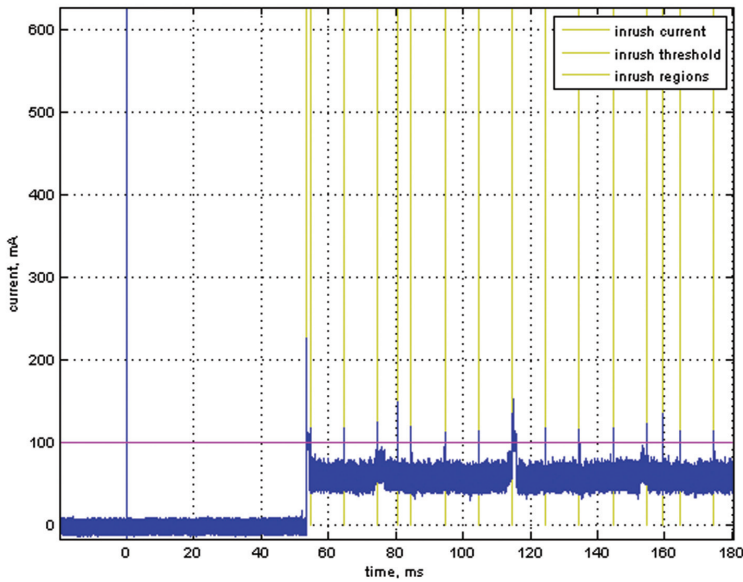

Figure 7. In-rush current spike.

Droop and Drop Testing

Droop and drop testing procedures vary based on whether the device is self-powered or bus powered.

Hosts and Self-Powered Hubs

Droop testing measures the DC voltage drop across each load board attached to the SQuIDD board. To get a good indication of voltage drop, the test is performed under two conditions—no load and load. Under no load testing, all downstream ports remain open, while the V_{BUS} voltage test points on the SQuIDD board are probed. Load testing tests the V_{BUS} voltage test points with 500-mA loads applied to all downstream ports. The lowest measured loaded value should be used for the droop test.

Droop testing involves measuring the AC voltage drop on V_{BUS} that occurs when all but one port are under 500-mA loads; The unloaded port is then connected to the SQuIDD board. Once the instantaneous AC voltage drop is captured on the display, markers are used to bracket the area between the lowest point and steady-state voltage point of V_{BUS} . Infiniium then uses the bracketed data to perform the droop test.

Bus-Powered Hubs

Droop tests for bus-powered hubs use 100-mA load boards instead of the 500-mA load boards used in the self-powered hub procedure. These 100-mA boards are connected to all downstream ports. The V_{BUS} voltage is then measured at the hub upstream port and at each downstream port. The lowest measured downstream value is used for the drop test.

The droop test for bus-powered hubs again uses the 100-mA-load board. This load board is connected to all but one port on the bus-powered device. The SQuIDD board is then attached to the unloaded port. Once again, markers are used to bracket the area between the lowest point on the captured data and the steady-state voltage. The Infiniium then uses the bracketed data to run the droop test.

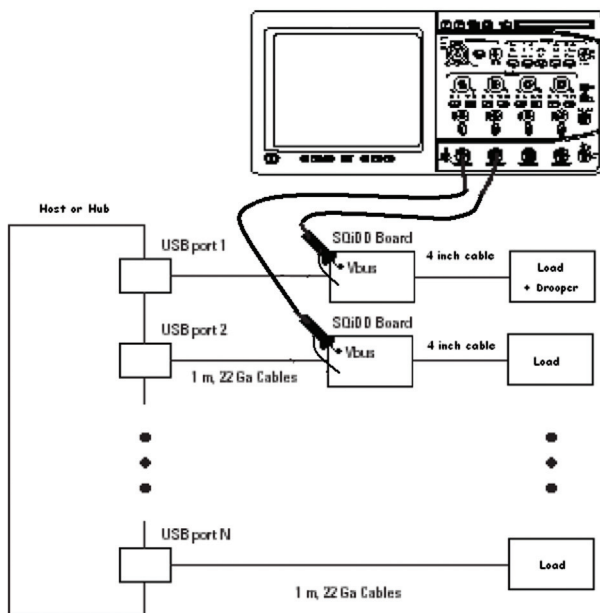

Figure 8. Droop setup for hosts and self-powered hubs.

Back-Drive Voltage Test

The back-drive voltage test is performed to ensure that a device only draws and does not source current from V_{BUS} on its upstream facing port at all times. If a device supplies current at this port, a number of consequences can occur, including hub enumeration failure, PC boot failure, and motherboard failure. This test measures the DC voltages of V_{BUS} , D+, and D- before and after device enumeration. The voltages are then recorded on the back-drive voltage fixture. Any voltage exceeding 400-mV is considered a failure.

Hi-Speed Electrical Test Suite

An additional suite of tests was added to the USB 2.0 compliance procedure to accommodate the new hi-speed mode. These tests include hi-speed signal quality, receiver sensitivity, CHIRP timing, and packet parameter.

Hi-Speed Electrical Test Tool

On the hi-speed USB Test Bed Computer, the USB hi-speed Electrical Test Tool is required.

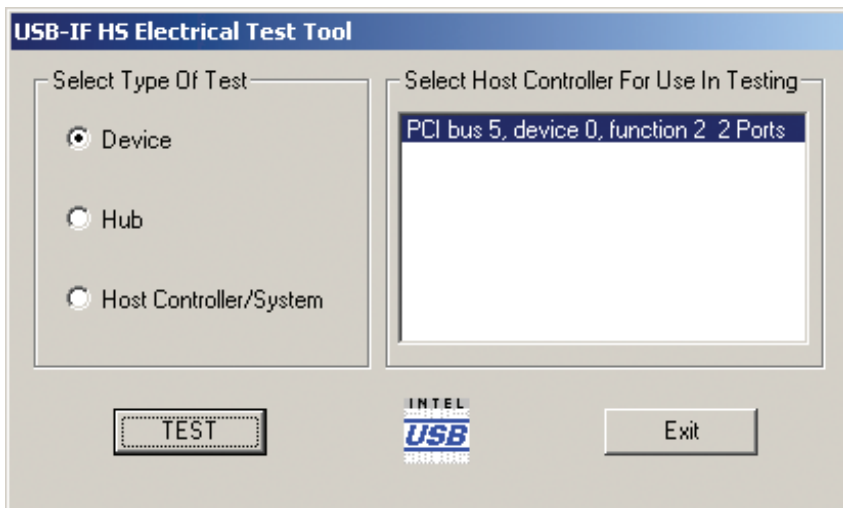

Figure 9. USB-IF hi-speed electrical test tool.

Hi-Speed Test Fixture

The hi-speed signal quality test utilizes the hi-speed signal quality board, as shown in Figure 10.

The nomenclatures of the test points differ between the Keysight hi-speed test fixture and the Intel test fixture. The official USB test procedure is written with reference to Keysight 's test fixtures. Refer to Table 5, the cross-reference chart, when using Intel's test fixture.

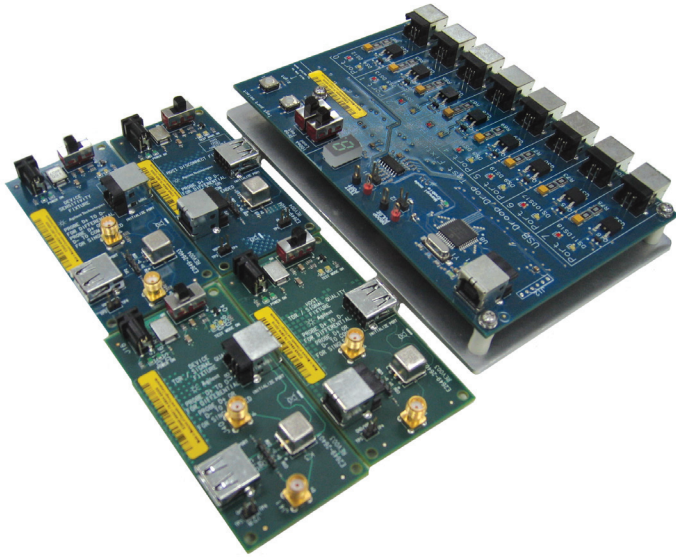

Figure 10. Hi-speed signal quality boards (Keysight fixture and Intel fixture—device signal quality test).

Intel's Fixtures	Description of the test points	Keysight Fixtures
J7	Test Point	TP2
J8	Power Port	J5
J10	Ground	TP5
J11	Ground	TP5
SMA1	D- line	SMA2
SMA2	D+ line	SMA1

Table 5. Cross-reference chart.

Hi-Speed Signal Quality Test

Invoke the Hi-speed Electrical Test Tool software on Electrical Test bed computer and select TEST_PACKET to perform the signal quality test. Figure 11 shows a hi-speed test packet captured on an Infiniium oscilloscope.

Prior to testing, it must be determined if the device incorporates a captive cable, or if it contains a series B or mini-B connector. During upstream tests, captive cables require that tests be run at the far end. B-connector cables require that tests be run at the near end. Figure 12 shows a hi-speed eye pattern result displayed on an Infiniium oscilloscope.

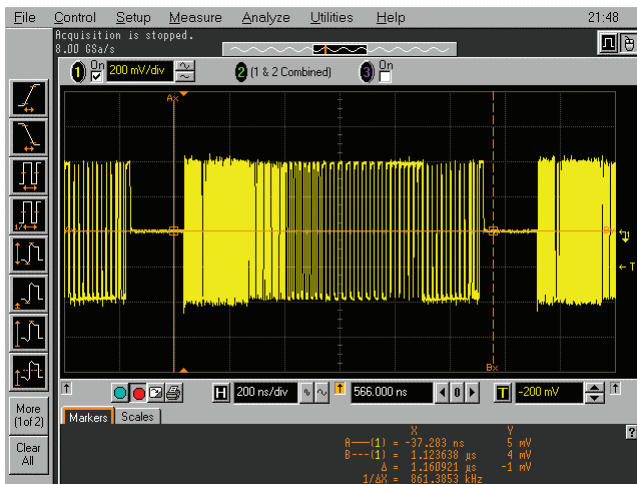

Figure 11. Hi-speed test packet.

Monotonicity

Monotonicity tests if a transmitted signal increases or decreases in amplitude without reversal in the opposite direction. The monotonicity characteristic of a signal can be viewed using the hi-speed signal quality eye template (Figure 12). There is no independent monotonicity test mandated by the USB-IF.

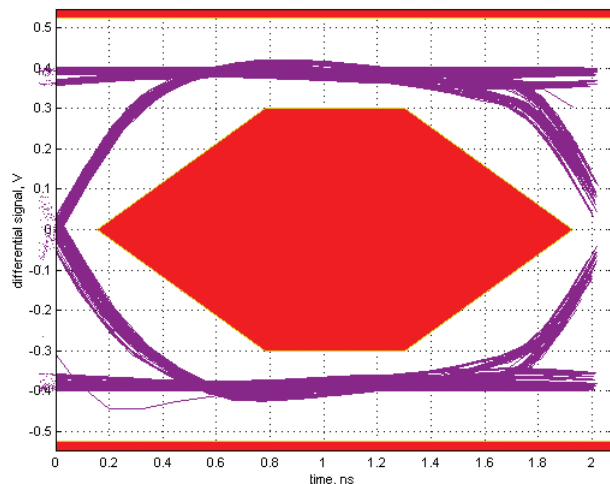

Figure 12. Hi-speed signal quality eye diagram.

Packet Parameters Test

Another test using the hi-speed signal quality board tests the device packet parameters. The hi-speed signal quality test board allows for better reception of the packets coming from the device. This test measures parameters such as sync field length, end of packet (EOP) width, and inter-packet gap.

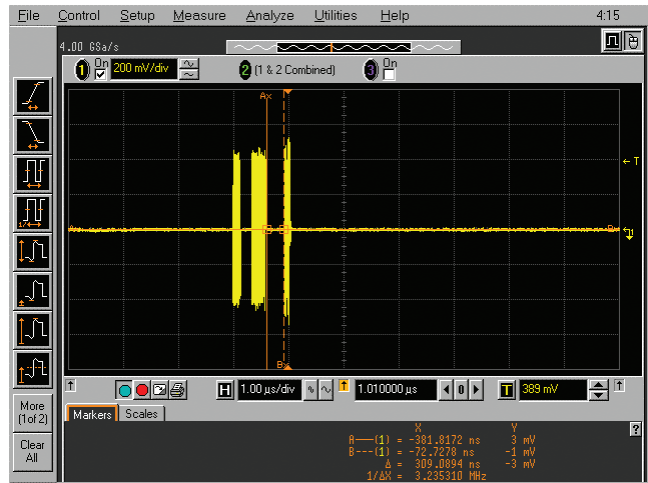

Figure 13. Device inter-packet gap.

Receiver Sensitivity

The receiver sensitivity tests verify sensitivity of the receivers of a device on both the upstream and downstream data ports in noisy environments. The Keysight 81130A/81134A Pulse/Pattern Generator is used to emulate IN commands from the port to the device address 1. IN commands are sent from the computer to the device under test, which should be in an unsquelched mode. The noise is represented by a pre-set level, whereby a signal meeting and exceeding this level responds to the IN command with a NAK. All packets from the data generator must be NAK'd by the port under test. The amplitude of the data generator packets is then reduced in 20-mV increments as the test is run. The amplitude of these packets should be reduced until the NAK packets become infrequent. The data generator amplitude is then immediately increased to the point where the NAK packets are not intermittent. This indicates the points of minimum receiver sensitivity levels before squelch.

When the device receives IN packets with a signal amplitude in excess of 150-mV, all packets should be NAK'd. When the device receives IN packets with a signal amplitude below 100-mV, all packets should be squelched. A waiver is granted for squelch at +/- 50-mV for each level.

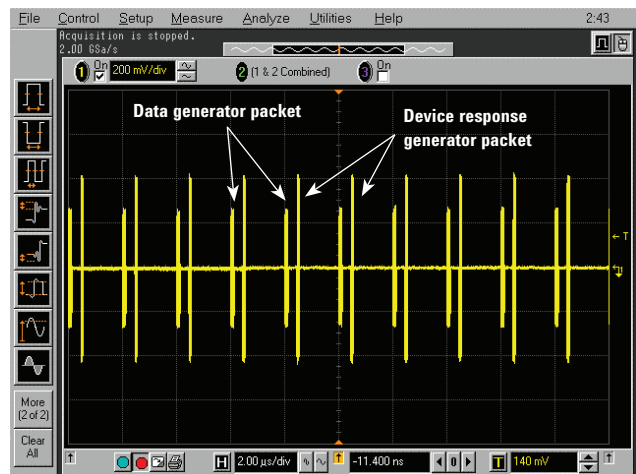

Figure 14. Receiver sensitivity test.

CHIRP Timing Test

The CHIRP test utilizes the hi-speed signal quality test fixture to measure timing and voltage on both upstream and downstream ports. The device is hot-plugged to the port and is immediately enumerated to capture the CHIRP handshake. Within the handshake, the CHIRP-K duration is measured to verify that it is within the 1.0-ms and 7.0-ms allowable latency. After the CHIRP K-J, K-J, K-J sequence, the device responds by turning on its hi-speed terminations. A drop of amplitude from 800-mV nominal to 400-mV nominal occurs. The time between the beginning of the last J in the CHIRP K-J, K-J, K-J sequence and the time when the device turn on initiates its hi-speed terminations must be measured to verify that it is less than or equal to 500- μ s.

In addition to measuring the time between the last J in CHIRP and the initiation of hi-speed termination, the CHIRP test also measures device suspend/resume/reset timing as well as the K and J amplitudes.

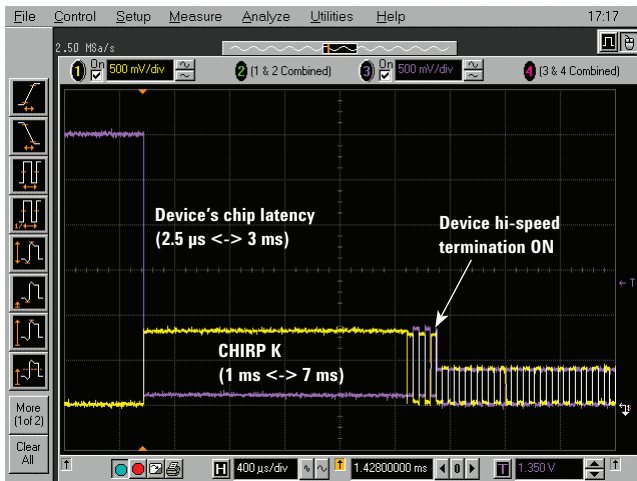

Figure 15. CHIRP test.



Figure 16. Time between last J in CHIRP and hi-speed termination initiation.

Impedance Measurements

In this test, differential time domain reflectometer (TDR) measurements are taken to measure the impedance of the hi-speed signaling path and active terminations of the device under test. The TDR measurements are compared with the USB-IF specification requirements. The device under test is powered, placed in SE0-NAK mode, and isolated from the system. D+ and D- are measured to verify that they are $0\text{-V} \pm 10\text{-mV}$. A 400-ps edge is then driven into the device. The resulting waveform indicates whether or not the termination impedance and the through impedance meet the requirements. The TDR measurement is not required for compliance testing. A PASS signal quality test will suffice for the TDR measurement.

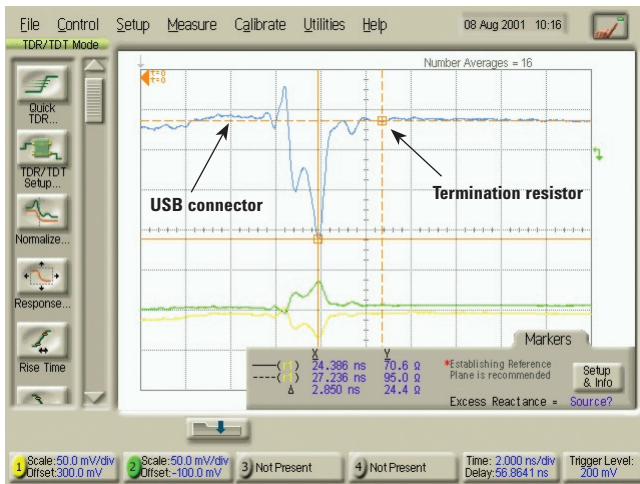

Figure 17. TDR measurement.

Summary

Keysight provides a comprehensive, easy-to-use solution for USB compliance testing. The compliance testing that once took days now takes only minutes. The individualized test boards provide flexibility and affordability for the laboratory choosing to test facets of the USB specification simultaneously.

In conclusion, the Keysight Infiniium USB Test Option has been described this way: *“The term ‘God Send’ comes to mind. Before the arrival of this scope, a USB test was something to be avoided! It often required half a day to set up the test and an additional 30 minutes to massage the numbers into an acceptable MATLAB format. Needless to say only the minimum number of tests required was ever actually performed.*

“In a nutshell, this product has revolutionized the way in which we look at USB. We now have a designated test system that is reliable and easy to use and fast. The main result is that we can now provide real-time feedback, and the amount of testing we perform is probably up 30-fold or more. And as you may have guessed, the additional testing has turned up a myriad of interesting opportunities for future improvements. Just for fun we have even started looking at our competitor’s products!”

Related Literature

Publication Title	Publication Type	Publication Number
<i>Infiniium USB Test Option N5416A</i>	Data sheet	5989-4044EN

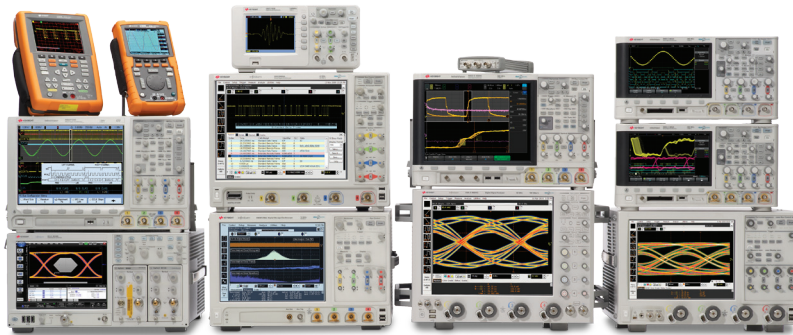

Keysight Technologies Oscilloscopes

Multiple form factors from 20 MHz to > 90 GHz | Industry leading specs | Powerful applications

myKeysight

myKeysight

www.keysight.com/find/mykeysight

A personalized view into the information most relevant to you.



www.axistandard.org

AdvancedTCA® Extensions for Instrumentation and Test (AXIe) is an open standard that extends the AdvancedTCA for general purpose and semiconductor test. Keysight is a founding member of the AXIe consortium. ATCA®, AdvancedTCA®, and the ATCA logo are registered US trademarks of the PCI Industrial Computer Manufacturers Group.



www.lxistandard.org

LAN eXtensions for Instruments puts the power of Ethernet and the Web inside your test systems. Keysight is a founding member of the LXI consortium.

Three-Year Warranty

www.keysight.com/find/ThreeYearWarranty

Keysight's commitment to superior product quality and lower total cost of ownership. The only test and measurement company with three-year warranty standard on all instruments, worldwide.



Keysight Assurance Plans

www.keysight.com/find/AssurancePlans

Up to five years of protection and no budgetary surprises to ensure your instruments are operating to specification so you can rely on accurate measurements.



www.keysight.com/quality

Keysight Technologies, Inc.
DEKRA Certified ISO 9001:2008
Quality Management System



Keysight Channel Partners

www.keysight.com/find/channelpartners

Get the best of both worlds: Keysight's measurement expertise and product breadth, combined with channel partner convenience.

This document was formerly known as application note number 1400

www.keysight.com/find/usb2_compliance

For more information on Keysight Technologies' products, applications or services, please contact your local Keysight office. The complete list is available at: www.keysight.com/find/contactus

Americas

Canada	(877) 894 4414
Brazil	55 11 3351 7010
Mexico	001 800 254 2440
United States	(800) 829 4444

Asia Pacific

Australia	1 800 629 485
China	800 810 0189
Hong Kong	800 938 693
India	1 800 112 929
Japan	0120 (421) 345
Korea	080 769 0800
Malaysia	1 800 888 848
Singapore	1 800 375 8100
Taiwan	0800 047 866
Other AP Countries	(65) 6375 8100

Europe & Middle East

Austria	0800 001122
Belgium	0800 58580
Finland	0800 523252
France	0805 980333
Germany	0800 6270999
Ireland	1800 832700
Israel	1 809 343051
Italy	800 599100
Luxembourg	+32 800 58580
Netherlands	0800 0233200
Russia	8800 5009286
Spain	0800 000154
Sweden	0200 882255
Switzerland	0800 805353
	Opt. 1 (DE)
	Opt. 2 (FR)
	Opt. 3 (IT)
United Kingdom	0800 0260637

For other unlisted countries:
www.keysight.com/find/contactus
(BP-07-10-14)